

## 具有 25 $\mu$ A 静态电流的 TPS7A65-Q1 300mA、40V 低压降稳压器

### 1 特性

- 低压降：
  - 在  $I_{OUT} = 150\text{mA}$  时为 300mV
- 7V 至 40V 的宽输入电压范围  
瞬态电压高达 45V
- 最大输出电流为 300mA
- 轻负载条件下的超低静态电流为 25 $\mu$ A（典型值）
- 3.3V 和 5V 固定输出电压，容差为  $\pm 2\%$
- 低 ESR 陶瓷输出稳定电容器
- 集成故障保护：
  - 短路和过流保护
  - 热关断
- 低输入电压跟踪
- 耐热增强型电源封装：
  - 3 引脚 TO-252 (KVU、DPAK)

### 2 应用

- 混合仪表组
- 换挡系统
- 抬头显示
- 汽车仪表组显示屏

### 3 说明

TPS7A65-Q1 低压降线性稳压器专为在轻负载应用中实现低功耗和小于 25 $\mu$ A 的静态电流而设计的要求。该器件具有集成式过流保护功能，采用的设计甚至在使用低 ESR 陶瓷输出电容器时也可实现稳定工作。低压跟踪特性允许使用更小的输入电容器并且有可能在冷启动期间无需使用升压转换器。凭借这些特性，此器件非常适合用于各种汽车应用的电源。

器件信息<sup>(1)</sup>

器件型号	封装	封装尺寸（标称值）
TPS7A65-Q1	TO-252 (3)	6.60mm × 6.10mm

(1) 如需了解所有可用封装，请参阅数据表末尾的封装选项附录。

典型应用电路原理图

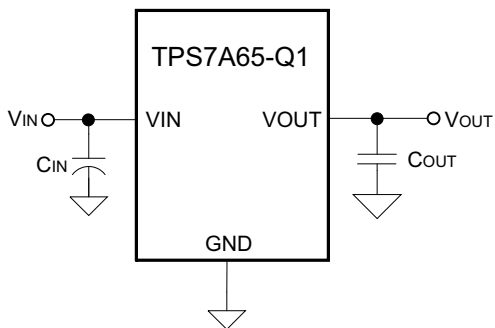

典型稳压器稳定性

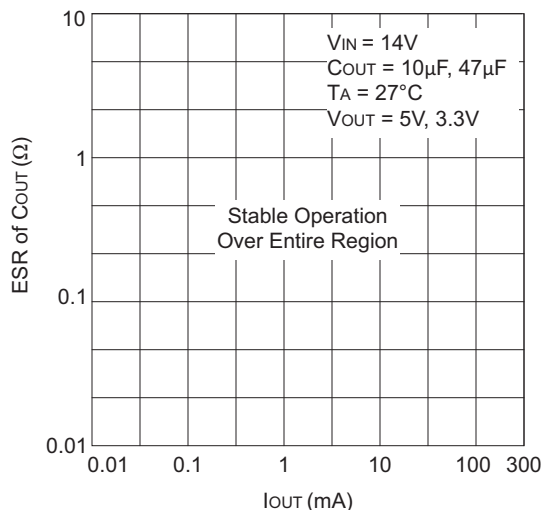

目录

1 特性 .....	1	7.3 Feature Description .....	10
2 应用 .....	1	7.4 Device Functional Modes .....	13
3 说明 .....	1	<b>8 Application and Implementation</b> .....	<b>14</b>
4 修订历史记录 .....	2	8.1 Application Information .....	14
<b>5 Pin Configuration and Functions</b> .....	<b>4</b>	8.2 Typical Application .....	14
<b>6 Specifications</b> .....	<b>5</b>	<b>9 Power Supply Recommendations</b> .....	<b>16</b>
6.1 Absolute Maximum Ratings .....	5	<b>10 Layout</b> .....	<b>16</b>
6.2 ESD Ratings .....	5	10.1 Layout Guidelines .....	16
6.3 Recommended Operating Conditions .....	5	10.2 Layout Example .....	19
6.4 Thermal Information .....	5	<b>11 器件和文档支持</b> .....	<b>20</b>
6.5 Electrical Characteristics .....	6	11.1 接收文档更新通知 .....	20
6.6 Dissipation Ratings .....	6	11.2 社区资源 .....	20
6.7 Typical Characteristics .....	7	11.3 商标 .....	20
<b>7 Detailed Description</b> .....	<b>10</b>	11.4 静电放电警告 .....	20
7.1 Overview .....	10	11.5 Glossary .....	20
7.2 Functional Block Diagram .....	10	<b>12 机械、封装和可订购信息</b> .....	<b>20</b>

4 修订历史记录

注：之前版本的页码可能与当前版本有所不同。

Changes from Revision E (May 2018) to Revision F	Page
• 已更改 将 11V 更改为 7V（位于 特性 部分的输入电压范围特性 项目符号） .....	1
• 已更改 更改了应用 部分 .....	1
• Changed $V_{IN}$ parameter minimum specification in <i>Recommended Operating Conditions</i> table from 11 V to 7 V and added footnote .....	5
• Changed $V_{IN}$ parameter minimum specification in <i>Electrical Characteristics</i> table from 11 V to 7 V and added footnote ....	6
• Changed 11 V to 7 V in <i>Input voltage range</i> row in <i>Design Parameters</i> table .....	14
• Changed input voltage range from 11 V to 40 V to 7 V to 40 V in <i>Power Supply Recommendations</i> section .....	16

Changes from Revision D (December 2015) to Revision E	Page
• 已更改 将 4V 更改为 11V（位于输入电压范围 特性 项目符号） .....	1
• Changed $V_{IN}$ parameter min specifications to 11 V from 5.3 V and 3.6 V .....	6
• Changed 4 V to 11 V in <i>Input voltage range</i> row in <i>Design Parameters</i> table .....	14
• Changed 4 V to 40 V in first sentence of <i>Power Supply Recommendations</i> section .....	16

Changes from Revision C (December 2011) to Revision D	Page
• 已添加 添加了引脚配置和功能 部分、ESD 额定值表、特性 说明 部分、器件功能模式 部分、应用和实施 部分、电源相关建议 部分、布局 部分、器件和文档支持 部分以及机械、封装和可订购信息 部分 .....	1

Changes from Revision B (November 2011) to Revision C	Page
• 删除了 TPS7A6533QKVURQ1 器件 .....	1
• Changed the Regulated Output Voltage (5.1). Added to Test Conditions "10mA to 300mA, $V_{IN} = V_{OUT} + 1V$ to 16V" .....	6

---

**Changes from Revision A (November 2011) to Revision B** **Page**

- Changed the  $\theta_{JP}$  value in the Abs Max Table From: 12.7 To: 1.2°C/W ..... **5**
- 

---

**Changes from Original (May 2010) to Revision A** **Page**

- Removed all KKT information..... **5**
-

## 5 Pin Configuration and Functions

**KVU Package  
3-Pin TO-252  
Top View**

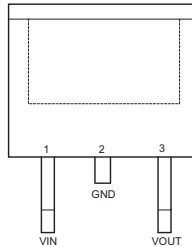

### Pin Functions

PIN		I/O	DESCRIPTION
NO.	NAME		
1	VIN	I	Input voltage pin: The unregulated input voltage is supplied to this pin. A bypass capacitor is connected between VIN pin and GND pin to dampen input line transients.
2	GND	I/O	Ground pin: This is signal ground pin of the IC.
3	VOUT	O	Regulated output voltage pin: This is a regulated voltage output ( $V_{OUT} = 3.3\text{ V}$ or $5\text{ V}$ , as applicable) pin with a limitation on maximum output current. To achieve stable operation and prevent oscillation, an external output capacitor ( $C_{OUT}$ ) with low ESR is connected between this pin and the GND pin.

## 6 Specifications

### 6.1 Absolute Maximum Ratings

over operating free-air temperature range (unless otherwise noted)<sup>(1)</sup>

		MIN	MAX	UNIT
V <sub>IN</sub>	Unregulated input <sup>(2)(3)</sup>		45	V
V <sub>OUT</sub>	Regulated output		7	V
θ <sub>JP</sub>	Thermal impedance junction to exposed pad		1.2	°C/W
T <sub>A</sub>	Operating ambient temperature		125	°C
T <sub>stg</sub>	Storage temperature	-65	150	°C

- (1) Stresses beyond those listed under *Absolute Maximum Ratings* may cause permanent damage to the device. These are stress ratings only, which do not imply functional operation of the device at these or any other conditions beyond those indicated under *Recommended Operating Conditions*. Exposure to absolute-maximum-rated conditions for extended periods may affect device reliability.
- (2) Absolute negative voltage on these pins not to go below -0.3 V.
- (3) Absolute maximum voltage for duration less than 480 ms.

### 6.2 ESD Ratings

			VALUE	UNIT
V <sub>(ESD)</sub>	Electrostatic discharge	Human body model (HBM), per AEC Q100-002 <sup>(1)</sup>	±2000	V

- (1) AEC Q100-002 indicates HBM stressing is done in accordance with the ANSI/ESDA/JEDEC JS-001 specification.

### 6.3 Recommended Operating Conditions

		MIN	MAX	UNIT
V <sub>IN</sub>	Unregulated input voltage	7 <sup>(1)</sup>	40	V
V <sub>EN</sub>	Enable pin voltage	4	40	V
T <sub>J</sub>	Operating junction temperature	-40	150	°C

- (1) V<sub>IN</sub> can go down to 4 V for 130 ms or less and remain functional. If V<sub>IN</sub> is less than 7 V for longer than 130 ms, then some devices may turn off until the input voltage rises above 7 V.

### 6.4 Thermal Information

THERMAL METRIC <sup>(1)</sup>			TPS7A65-Q1	UNIT
			KVU (TO-252)	
			3 PINS	
R <sub>θJA</sub>	Junction-to-ambient thermal resistance	High-K profile <sup>(2)</sup>	29.3	°C/W
		Low-K profile <sup>(3)</sup>	38.6	°C/W
R <sub>θJC(top)</sub>	Junction-to-case (top) thermal resistance		N/A	°C/W
R <sub>θJB</sub>	Junction-to-board thermal resistance		8.2	°C/W
ψ <sub>JT</sub>	Junction-to-top characterization parameter		3.4	°C/W
ψ <sub>JB</sub>	Junction-to-board characterization parameter		8.1	°C/W
R <sub>θJC(bot)</sub>	Junction-to-case (bottom) thermal resistance		1.1	°C/W

- (1) For more information about traditional and new thermal metrics, see the [Semiconductor and IC Package Thermal Metrics](#) application report.
- (2) The thermal data is based on JEDEC standard high-K profile – JESD 51-5. The copper pad is soldered to the thermal land pattern. Also correct attachment procedure must be incorporated.
- (3) The thermal data is based on JEDEC standard low-K profile – JESD 51-3. The copper pad is soldered to the thermal land pattern. Also correct attachment procedure must be incorporated.

## 6.5 Electrical Characteristics

 $V_{IN} = 14\text{ V}$ ,  $T_J = -40^\circ\text{C}$  to  $+150^\circ\text{C}$  (unless otherwise noted)

PARAMETER		TEST CONDITIONS	MIN	TYP	MAX	UNIT
<b>INPUT VOLTAGE (VIN Pin)</b>						
$V_{IN}$	Input voltage	Fixed 5-V output, $I_{OUT} = 1\text{ mA}$	7 <sup>(1)</sup>		40	V
		Fixed 3.3-V output, $I_{OUT} = 1\text{ mA}$	7 <sup>(1)</sup>		40	
$I_{QUIESCENT}$	Quiescent current	$V_{IN} = 8.2\text{ V}$ to $18\text{ V}$ , $I_{OUT} = 0.01\text{ mA}$ to $0.75\text{ mA}$		25	40	$\mu\text{A}$
$V_{IN-UVLO}$	Undervoltage lockout voltage	Ramp $V_{IN}$ down until output is turned OFF		3.16		V
$V_{IN(PowerUP)}$	Power-up voltage	Ramp $V_{IN}$ up until output is turned ON		3.45		V
<b>REGULATED OUTPUT VOLTAGE (VOUT Pin)</b>						
$V_{OUT}$	Regulated output voltage	Fixed $V_{OUT}$ value (3.3 V or 5 V as applicable), $I_{OUT} = 10\text{ mA}$ , 10 mA to 300 mA, $V_{IN} = V_{OUT} + 1\text{ V}$ to $16\text{ V}$	-2%		2%	
$\Delta V_{LINE-REG}$	Line regulation	$V_{IN} = 6\text{ V}$ to $28\text{ V}$ , $I_{OUT} = 10\text{ mA}$ , $V_{OUT} = 5\text{ V}$			15	mV
		$V_{IN} = 6\text{ V}$ to $28\text{ V}$ , $I_{OUT} = 10\text{ mA}$ , $V_{OUT} = 3.3\text{ V}$			20	
$\Delta V_{LOAD-REG}$	Load regulation	$I_{OUT} = 10\text{ mA}$ to $300\text{ mA}$ , $V_{IN} = 14\text{ V}$ , $V_{OUT} = 5\text{ V}$			25	mV
		$I_{OUT} = 10\text{ mA}$ to $300\text{ mA}$ , $V_{IN} = 14\text{ V}$ , $V_{OUT} = 3.3\text{ V}$			35	
$V_{DROPOUT}^{(2)}$	Dropout voltage ( $V_{IN} - V_{OUT}$ )	$I_{OUT} = 250\text{ mA}$			500	mV
		$I_{OUT} = 150\text{ mA}$			300	
$R_{SW}^{(3)}$	Switch resistance	$V_{IN}$ to $V_{OUT}$ resistance			2	$\Omega$
$I_{OUT}$	Output current	$V_{OUT}$ in regulation	0		300	mA
$I_{CL}$	Output current limit	$V_{OUT} = 0\text{ V}$ ( $V_{OUT}$ pin is shorted to ground)	350		1000	mA
PSRR <sup>(3)</sup>	Power-supply ripple rejection	$V_{IN-RIPPLE} = 0.5\text{ Vpp}$ , $I_{OUT} = 300\text{ mA}$ , frequency = 100 Hz, $V_{OUT} = 5\text{ V}$ , $V_{OUT} = 3.3\text{ V}$		60		dB
		$V_{IN-RIPPLE} = 0.5\text{ Vpp}$ , $I_{OUT} = 300\text{ mA}$ , frequency = 150 kHz, $V_{OUT} = 5\text{ V}$ , $V_{OUT} = 3.3\text{ V}$		30		
<b>TEMPERATURE</b>						
$T_{SHUTDOWN}$	Thermal shutdown trip point			165		$^\circ\text{C}$
$T_{HYST}$	Thermal shutdown hysteresis			10		$^\circ\text{C}$

- $V_{IN}$  can go down to 4 V for 130 ms or less and remain functional. If  $V_{IN}$  is less than 7 V for longer than 130 ms, then some devices may turn off until the input voltage rises above 7 V.
- This test is done with  $V_{OUT}$  in regulation and  $V_{IN} - V_{OUT}$  parameter is measured when  $V_{OUT}$  (3.3 V or 5 V) drops by 100 mV at specified loads.
- Specified by design; not tested.

## 6.6 Dissipation Ratings

JEDEC STANDARD	PACKAGE	$T_A < 25^\circ\text{C}$ POWER RATING (W)	DERATING FACTOR ABOVE $T_A = 25^\circ\text{C}$ ( $^\circ\text{C}/\text{W}$ )	$T_A = 85^\circ\text{C}$ POWER RATING (W)
JEDEC Standard PCB - low K, JESD 51-3	3-pin KVU	3.24	38.6	1.68
JEDEC Standard PCB - high K, JESD 51-5	3-pin KVU	4.27	29.3	2.22

### 6.7 Typical Characteristics

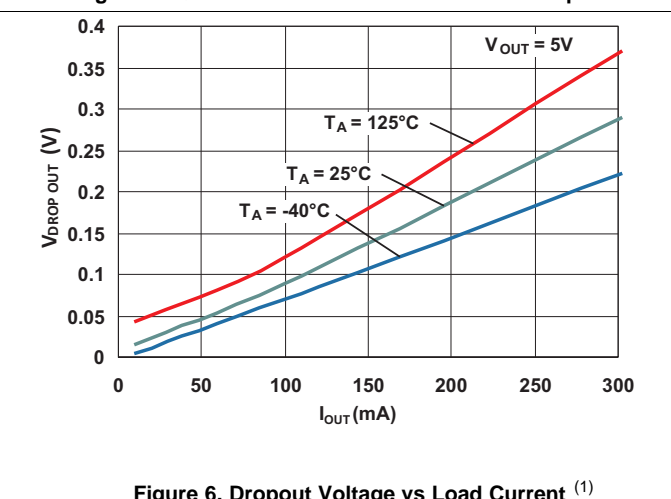
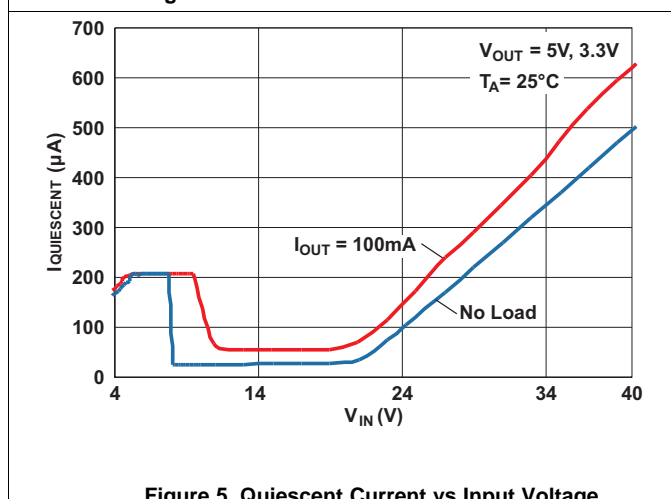
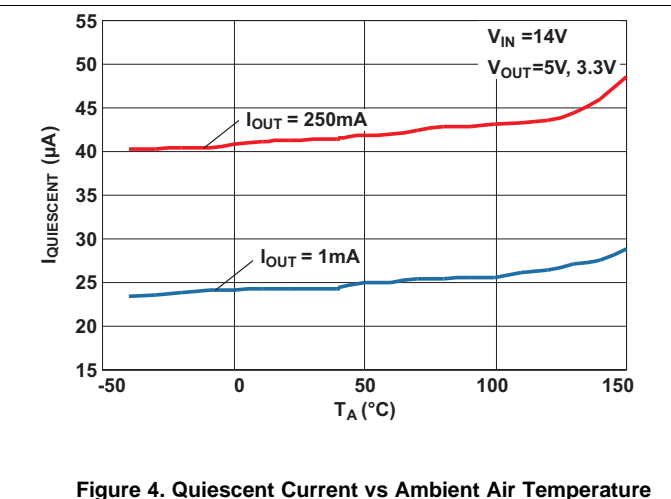
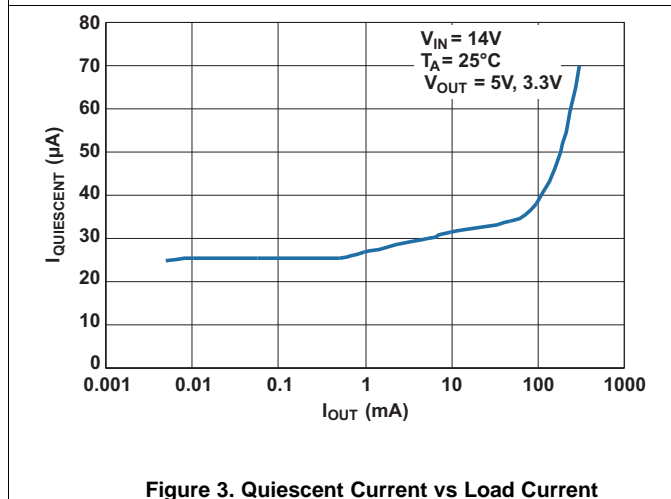
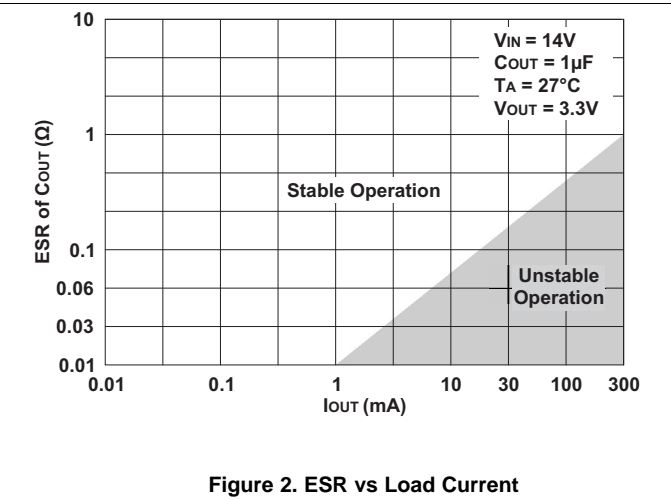
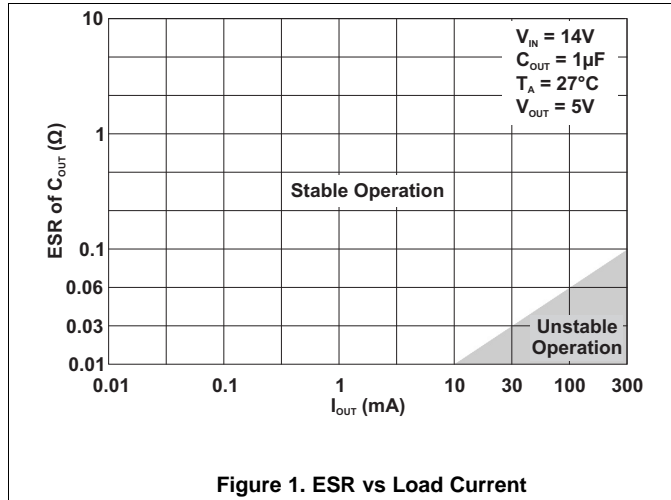

(1) Dropout voltage is measured when the output voltage drops by 100 mV from the regulated output voltage level. (For example, the drop out voltage for TPS7A6550 is measured when the output voltage drops down to 4.9 V from 5 V.)

Typical Characteristics (continued)

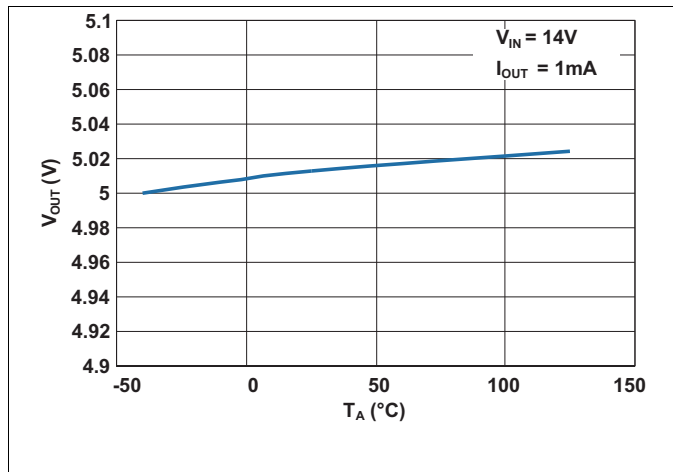

Figure 7. Output Voltage vs Ambient Air Temperature

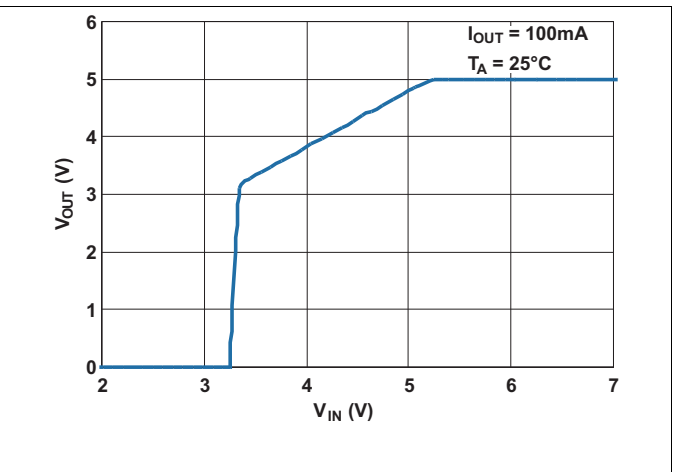

Figure 8. Output Voltage vs Input Voltage

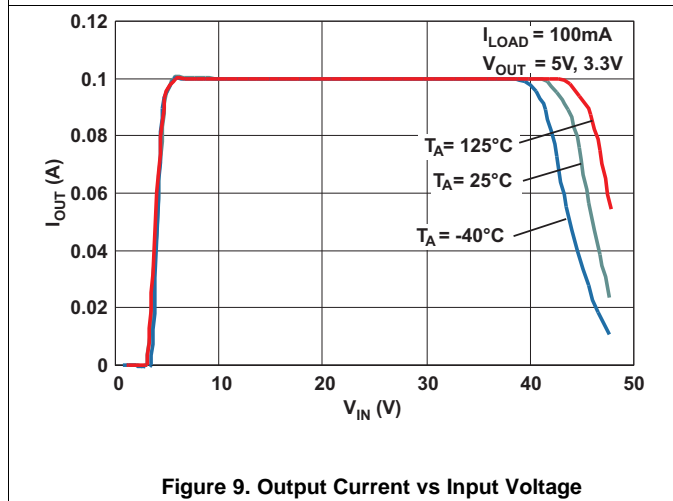

Figure 9. Output Current vs Input Voltage

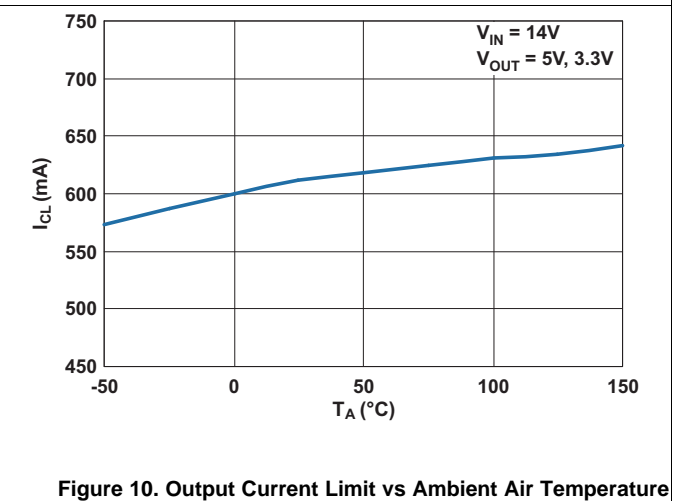

Figure 10. Output Current Limit vs Ambient Air Temperature

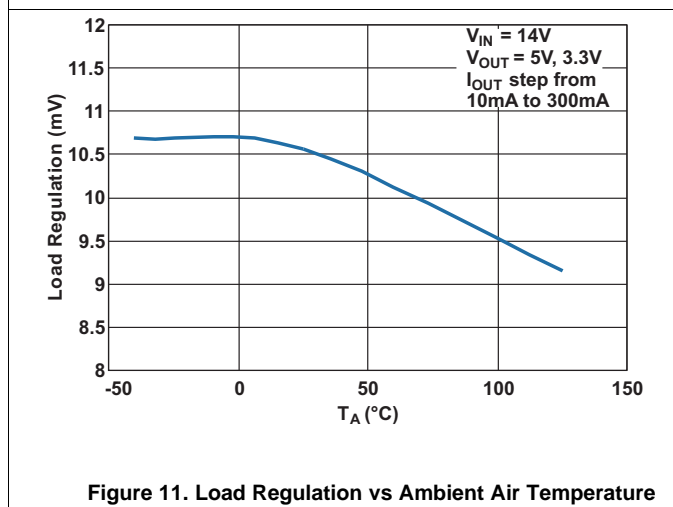

Figure 11. Load Regulation vs Ambient Air Temperature

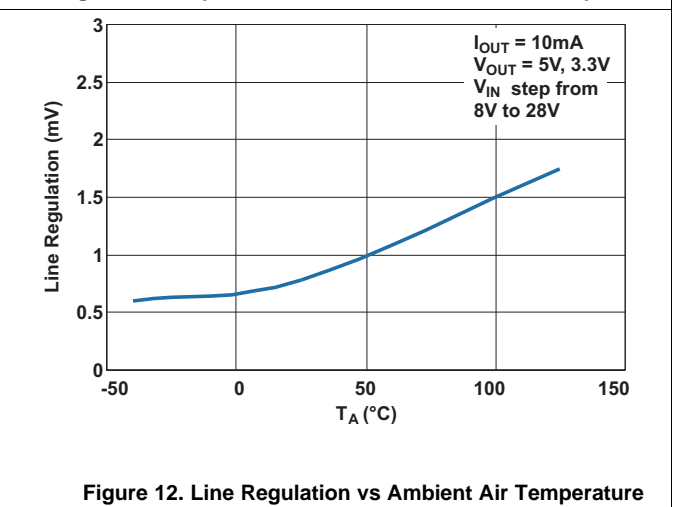
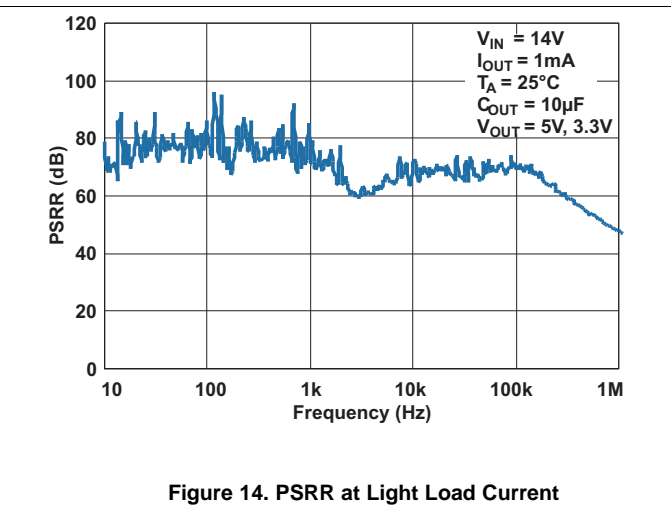
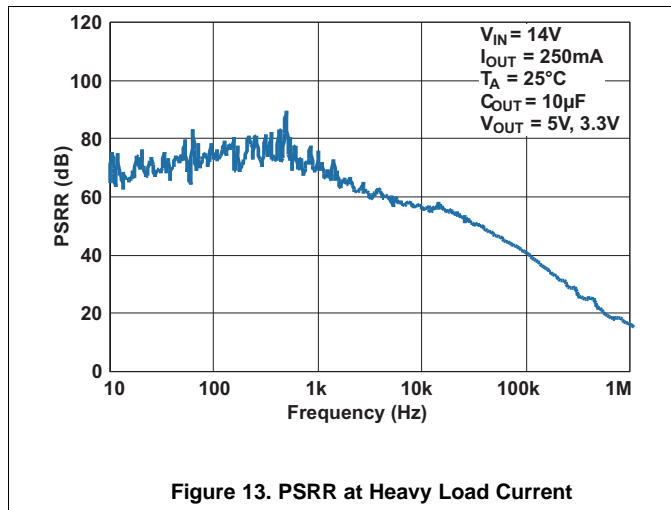

Figure 12. Line Regulation vs Ambient Air Temperature



Typical Characteristics (continued)



## 7 Detailed Description

### 7.1 Overview

The TPS7A65-Q1 is a monolithic low-dropout linear voltage regulator designed for low-power consumption and quiescent current less than 25  $\mu\text{A}$  in light-load applications. Because of an integrated fault protection, this device is well-suited in power supplies for various automotive applications.

This device is available in two fixed-output-voltage versions as follows:

- 5-V output version (TPS7A6550-Q1)
- 3.3-V output version (TPS7A6533-Q1)

See [Feature Description](#) for full descriptions of the features of the TPS7A65-Q1 voltage regulator.

### 7.2 Functional Block Diagram

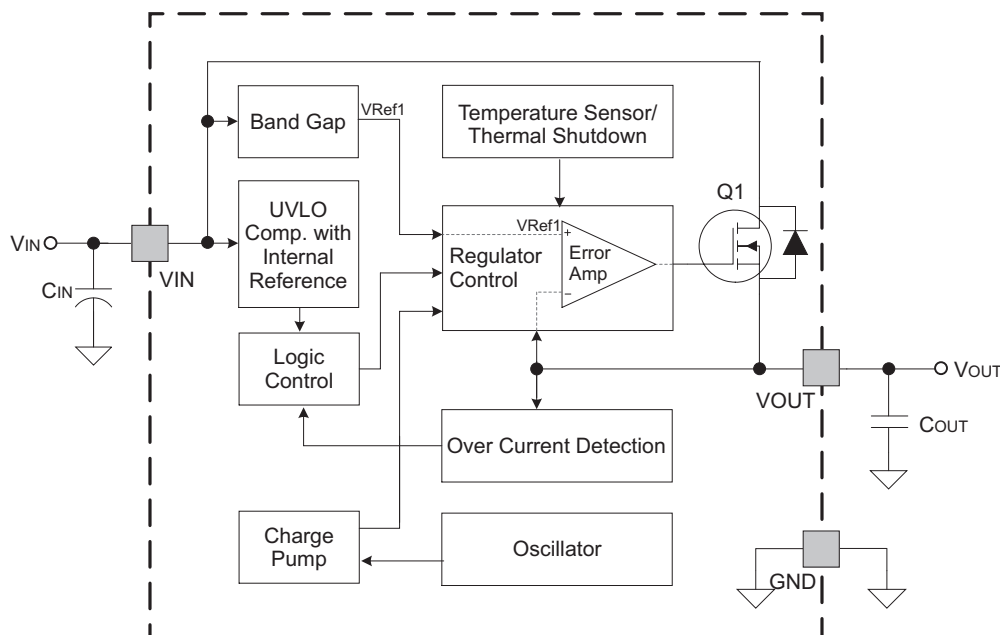

### 7.3 Feature Description

#### 7.3.1 Power Up

During power up, the regulator incorporates a protection scheme to limit the current through the pass element and output capacitor. When the input voltage exceeds a certain threshold ( $V_{\text{IN(POWERUP)}}$ ) level, the output voltage begins to ramp up; see [Figure 15](#).

Feature Description (continued)

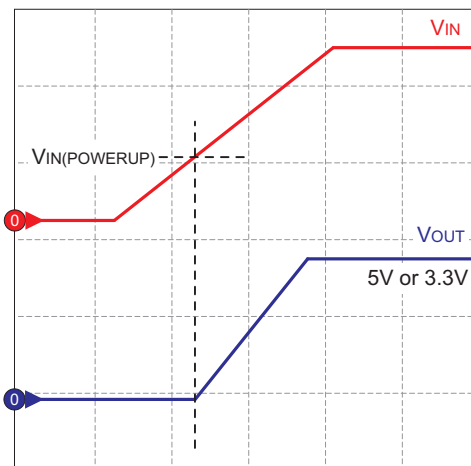

Figure 15. Power-Up Sequence

7.3.2 Charge-Pump Operation

This device has an internal charge pump that turns on or off depending on the input voltage and the output current. The charge pump switching circuitry does not cause conducted emissions to exceed required thresholds on the input voltage line. For a given output current, the charge pump stays on at lower input voltages and turns off at higher input voltages. The charge-pump switching thresholds are hysteretic. Figure 16 and Figure 17 show typical switching thresholds for the charge pump at light ( $I_{OUT} < \text{approximately } 2 \text{ mA}$ ) and heavy ( $I_{OUT} > \text{approximately } 2 \text{ mA}$ ) loads, respectively.

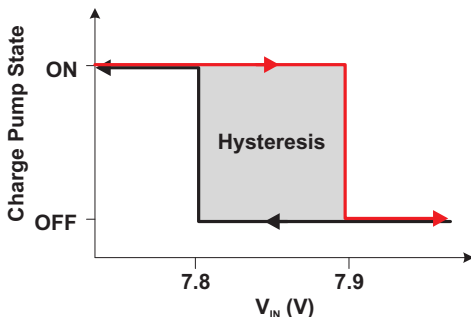

Figure 16. Charge-Pump Operation at Light Loads

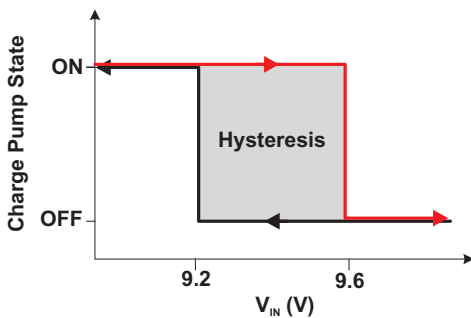

Figure 17. Charge-Pump Operation at Heavy Loads

## Feature Description (continued)

### 7.3.3 Low-Power Mode

At light loads and high input voltages ( $V_{IN} >$  approximately 8 V such that charge pump is off) the device operates in the low-power mode and the quiescent current consumption decreases to 25  $\mu$ A (typical) as shown in Table 1.

**Table 1. Typical Quiescent Current Consumption**

$I_{OUT}$	CHARGE PUMP ON	CHARGE PUMP OFF
$I_{OUT} <$ approximately 2 mA (light load)	250 $\mu$ A	25 $\mu$ A (low-power mode)
$I_{OUT} >$ approximately 2 mA (heavy load)	280 $\mu$ A	70 $\mu$ A

### 7.3.4 Undervoltage Shutdown

This device has an integrated undervoltage lockout (UVLO) circuit to shut down the output if the input voltage ( $V_{IN}$ ) falls below an internally fixed UVLO threshold level ( $V_{IN-UVLO}$ ) as shown in Figure 18. This ensures that the regulator does not latch into an unknown state during low input-voltage conditions. The regulator normally powers up when the input voltage exceeds the  $V_{IN(POWERUP)}$  threshold.

### 7.3.5 Low-Voltage Tracking

At low input voltages, the regulator drops out of regulation, and the output voltage tracks input minus a voltage based on the load current ( $I_{OUT}$ ) and switch resistance ( $R_{SW}$ ) as shown in Figure 18. This allows for a smaller input capacitor and can possibly eliminate the need of using a boost converter during cold-crank conditions.

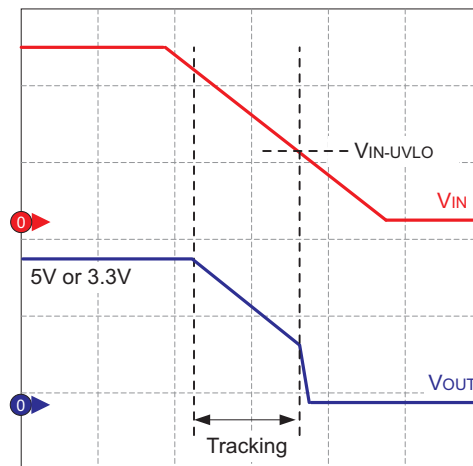

**Figure 18. Undervoltage Shutdown and Low-Voltage Tracking**

### 7.3.6 Integrated Fault Protection

This device features integrated fault protection to make them ideal for use in automotive applications. To keep the device in a safe area of operation during certain fault conditions, the device uses internal current limit protection and current limit foldback to limit the maximum output current. This protects the device from excessive power dissipation. For example, during a short-circuit condition on the output, limiting current through the pass element to  $I_{CL}$  protects the device from excessive power dissipation.

### 7.3.7 Thermal Shutdown

This device incorporates a thermal shutdown (TSD) circuit as a protection from overheating. For continuous normal operation, the junction temperature should not exceed the TSD trip point. If the junction temperature exceeds the TSD trip point, the output turns off. When the junction temperature falls below the TSD trip point, the output turns on again. Figure 19 shows this.

## Feature Description (continued)

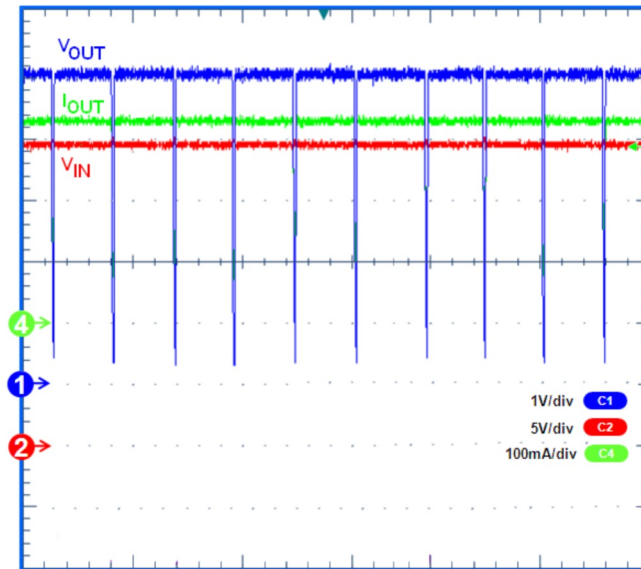

Figure 19. Thermal Cycling Waveform for TPS7A6550-Q1 ( $V_{IN} = 24\text{ V}$ ,  $I_{OUT} = 300\text{ mA}$ ,  $V_{OUT} = 5\text{ V}$ )

## 7.4 Device Functional Modes

### 7.4.1 Operation With $V_{IN}$ Lower Than 4 V

The TPS7A65-Q1 device operates with input voltage above 4 V. The typical UVLO voltage is 3.16 V, the device can operate at input voltage lower than 4 V. But at input voltage below the actual UVLO, the device shuts down.

### 7.4.2 Operation With $V_{IN}$ Larger Than 4 V

When  $V_{IN}$  is greater than 4 V, if the input voltage is higher than  $V_{OUT}$  plus the dropout voltage, the output voltage is equal to the set value. Otherwise, the output voltage is equal to  $V_{IN}$  minus the dropout voltage.

## 8 Application and Implementation

### NOTE

Information in the following applications sections is not part of the TI component specification, and TI does not warrant its accuracy or completeness. TI's customers are responsible for determining suitability of components for their purposes. Customers should validate and test their design implementation to confirm system functionality.

### 8.1 Application Information

The TPS7A65-Q1 is a low-dropout linear voltage regulator designed for low power consumption and quiescent current less than 25  $\mu\text{A}$  in light-load applications. This device features integrated overcurrent protection and a design to achieve stable operation even with low-ESR ceramic output capacitors. A low-voltage tracking feature allows for a smaller input capacitor and can possibly eliminate the need of using a boost converter during cold crank conditions. Because of these features, this device is well-suited in power supplies for various automotive applications.

### 8.2 Typical Application

A typical application circuit for TPS7A65-Q1 is [Figure 20](#). Depending on the end application, one may use different values of external components. An application may require a larger output capacitor during fast load steps to prevent the output from temporarily dropping down. TI recommends a low-ESR ceramic capacitor with dielectric of type X5R or X7R. The user can additionally connect a bypass capacitor at the output to decouple high-frequency noise as per the end application.

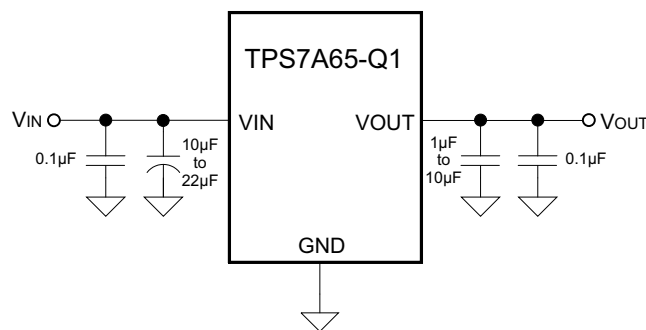

**Figure 20. Typical Application Schematic**

#### 8.2.1 Design Requirements

[Table 2](#) lists the parameters for this design example.

**Table 2. Design Parameters**

DESIGN PARAMETER	EXAMPLE VALUE
Input voltage range	7 V to 40 V
Output voltage	3.3 V, 5 V
Output current rating	300 mA maximum
Output capacitor range	1 $\mu\text{F}$ to 10 $\mu\text{F}$

### 8.2.2 Detailed Design Procedure

When using the TPS7A6533-Q1, TPS7A6550-Q1, TI recommends adding a 10- $\mu$ F to 22- $\mu$ F capacitor to the input to keep the input voltage stable. TI also recommends adding a 1- $\mu$ F to 10- $\mu$ F low ESR ceramic capacitor to get a stable output.

### 8.2.3 Application Curve

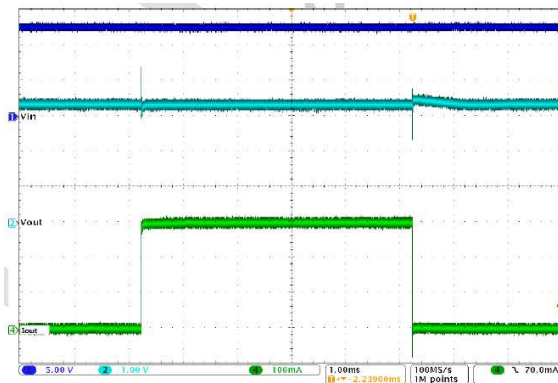

**Figure 21. TPS7A6533-Q1 Load Transient Waveform**

## 9 Power Supply Recommendations

The device is designed to operate from an input-voltage supply range from 7 V to 40 V. This input supply must be well regulated. If the input supply is located more than a few inches from the TPS7A65-Q1 device, TI recommends adding an electrolytic capacitor with a value of 10  $\mu$ F and a ceramic bypass capacitor at the input.

## 10 Layout

### 10.1 Layout Guidelines

For the LDO power supply, especially these high voltage and large current ones, layout is an important step. If layout is not carefully designed, the regulator could not deliver enough output current because of the thermal limitation. To improve the thermal performance of the device, and maximize the current output at high ambient temperature, TI recommends spreading the thermal pad as large as possible and putting enough thermal vias on the thermal pad.

#### 10.1.1 Power Dissipation and Thermal Considerations

Calculate the power dissipated in the device using [Equation 1](#).

$$P_D = I_{OUT} \times (V_{IN} - V_{OUT}) + I_{QUIESCENT} \times V_{IN}$$

where

- $P_D$  = continuous power dissipation
- $I_{OUT}$  = output current
- $V_{IN}$  = input voltage
- $V_{OUT}$  = output voltage
- $I_{QUIESCENT}$  = quiescent current.

(1)

$I_{QUIESCENT} \ll I_{OUT}$ ; therefore, ignore the term  $I_{QUIESCENT} \times V_{IN}$  in [Equation 1](#).

For a device under operation at a given ambient air temperature ( $T_A$ ), calculate the junction temperature ( $T_J$ ) using [Equation 2](#).

$$T_J = T_A + (\theta_{JA} \times P_D)$$

where

- $\theta_{JA}$  = junction-to-ambient air thermal impedance.

(2)

Calculate the rise in junction temperature due to power dissipation using [Equation 3](#).

$$\Delta T = T_J - T_A = (\theta_{JA} \times P_D)$$

(3)

For a given maximum junction temperature ( $T_{J-Max}$ ), calculate the maximum ambient air temperature ( $T_{A-Max}$ ) at which the device can operate using [Equation 4](#).

$$T_{A-Max} = T_{J-Max} - (\theta_{JA} \times P_D)$$

(4)

#### Example

If  $I_{OUT} = 100$  mA,  $V_{OUT} = 5$  V,  $V_{IN} = 14$  V,  $I_{QUIESCENT} = 250$   $\mu$ A and  $\theta_{JA} = 30^\circ\text{C/W}$ , the continuous power dissipated in the device is 0.9 W. The rise in junction temperature due to power dissipation is  $27^\circ\text{C}$ . For a maximum junction temperature of  $150^\circ\text{C}$ , maximum ambient air temperature at which the device can operate is  $123^\circ\text{C}$ .

For adequate heat dissipation, TI recommends soldering the power pad (exposed heat sink) to the thermal land pad on the PCB. Doing this provides a heat conduction path from the die to the PCB and reduces overall package thermal resistance. [Figure 22](#) shows power derating curves for the TPS7A65-Q1 family of devices in the KVU (DPAK) package.



**Layout Guidelines (continued)**

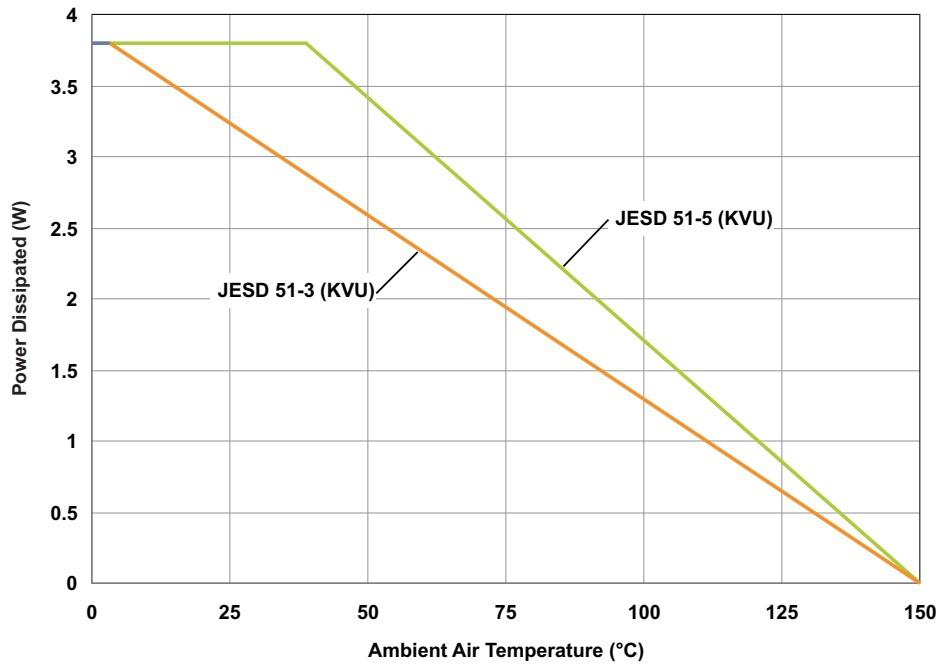

**Figure 22. Power Derating Curves**

For optimum thermal performance, TI recommends using a high-K PCB with thermal vias between the ground plane and solder pad or thermal land pad. [Figure 23](#) (a) and (b) show this. Further, a design can improve the heat-spreading capabilities of a PCB considerably by using a thicker ground plane and a thermal land pad with a larger surface area.

**Layout Guidelines (continued)**

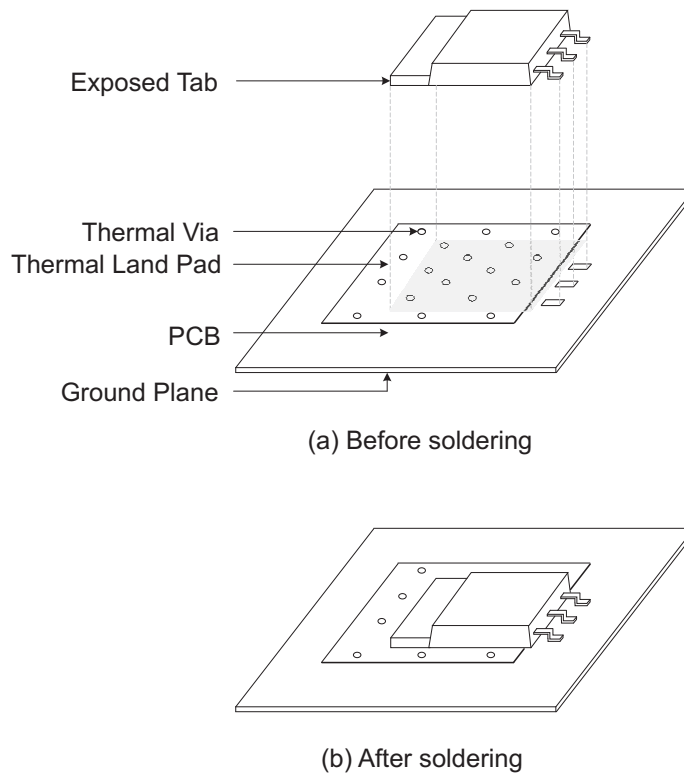

**Figure 23. Using a Multilayer PCB and Thermal Vias for Adequate Heat Dissipation**

Keeping other factors constant, the surface area of the thermal land pad contributes to heat dissipation only to a certain extent. [Figure 24](#) shows the variation of  $\theta_{JA}$  with surface area of the thermal land pad (soldered to the exposed pad) for the KVVU package.

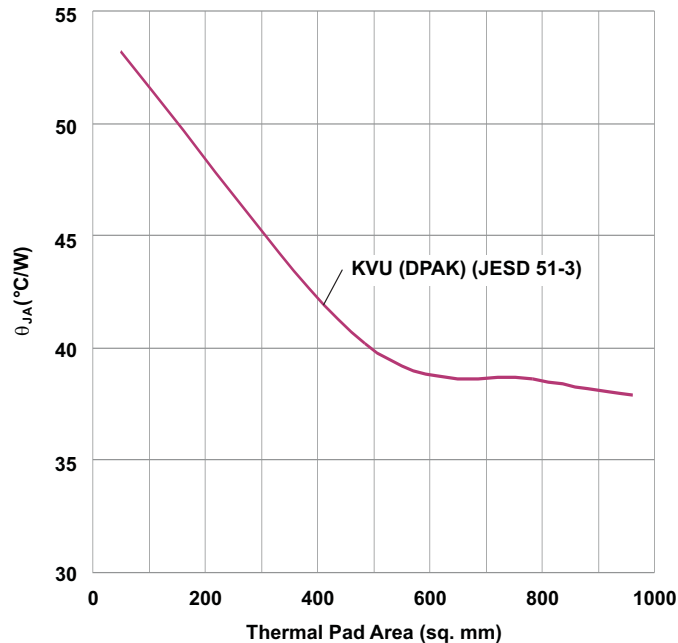

**Figure 24.  $\theta_{JA}$  vs Thermal Pad Area**

## 10.2 Layout Example

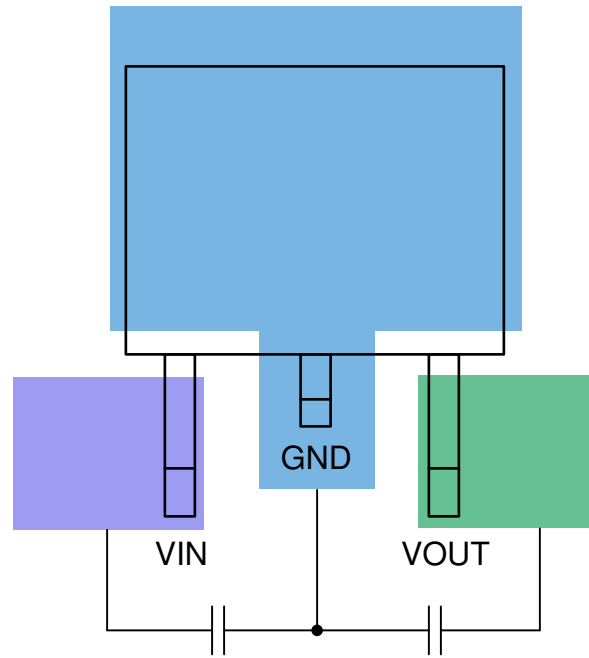

Figure 25. Layout Recommendation

## 11 器件和文档支持

### 11.1 接收文档更新通知

要接收文档更新通知，请导航至 [ti.com.cn](http://ti.com.cn) 上的器件产品文件夹。单击右上角的通知我进行注册，即可每周接收产品信息更改摘要。有关更改的详细信息，请查看任何已修订文档中包含的修订历史记录。

### 11.2 社区资源

TI E2E™ support forums are an engineer's go-to source for fast, verified answers and design help — straight from the experts. Search existing answers or ask your own question to get the quick design help you need.

Linked content is provided "AS IS" by the respective contributors. They do not constitute TI specifications and do not necessarily reflect TI's views; see TI's [Terms of Use](#).

### 11.3 商标

E2E is a trademark of Texas Instruments.

All other trademarks are the property of their respective owners.

### 11.4 静电放电警告



ESD 可能会损坏该集成电路。德州仪器 (TI) 建议通过适当的预防措施处理所有集成电路。如果不遵守正确的处理措施和安装程序，可能会损坏集成电路。

ESD 的损坏小至导致微小的性能降级，大至整个器件故障。精密的集成电路可能更容易受到损坏，这是因为非常细微的参数更改都可能会导致器件与其发布的规格不相符。

### 11.5 Glossary

[SLYZ022](#) — *TI Glossary*.

This glossary lists and explains terms, acronyms, and definitions.

## 12 机械、封装和可订购信息

以下页面包含机械、封装和可订购信息。这些信息是指定器件的最新可用数据。数据如有变更，恕不另行通知，且不会对此文档进行修订。如需获取此数据表的浏览器版本，请查阅左侧的导航栏。

## 重要声明和免责声明

TI 均以“原样”提供技术性及其可靠性数据（包括数据表）、设计资源（包括参考设计）、应用或其他设计建议、网络工具、安全信息和其他资源，不保证其中不含任何瑕疵，且不做任何明示或暗示的担保，包括但不限于对适销性、适合某特定用途或不侵犯任何第三方知识产权的暗示担保。

所述资源可供专业开发人员应用TI 产品进行设计使用。您将对以下行为独自承担全部责任：(1) 针对您的应用选择合适的TI 产品；(2) 设计、验证并测试您的应用；(3) 确保您的应用满足相应标准以及任何其他安全、安保或其他要求。所述资源如有变更，恕不另行通知。TI 对您使用所述资源的授权仅限于开发资源所涉及TI 产品的相关应用。除此之外不得复制或展示所述资源，也不提供其它TI 或任何第三方的知识产权授权许可。如因使用所述资源而产生任何索赔、赔偿、成本、损失及债务等，TI 对此概不负责，并且您须赔偿由此对TI 及其代表造成的损害。

TI 所提供产品均受TI 的销售条款 (<http://www.ti.com.cn/zh-cn/legal/termsofsale.html>) 以及ti.com.cn上或随附TI产品提供的其他可适用条款的约束。TI提供所述资源并不扩展或以其他方式更改TI 针对TI 产品所发布的可适用的担保范围或担保免责声明。

邮寄地址：上海市浦东新区世纪大道 1568 号中建大厦 32 楼，邮政编码：200122  
Copyright © 2020 德州仪器半导体技术（上海）有限公司

**PACKAGING INFORMATION**

Orderable Device	Status (1)	Package Type	Package Drawing	Pins	Package Qty	Eco Plan (2)	Lead finish/ Ball material (6)	MSL Peak Temp (3)	Op Temp (°C)	Device Marking (4/5)	Samples
TPS7A6533QKVURQ1	ACTIVE	TO-252	KVU	3	2500	RoHS & Green	SN	Level-3-260C-168 HR	-40 to 125	7A6533Q1	<a href="#">Samples</a>
TPS7A6550QKVURQ1	ACTIVE	TO-252	KVU	3	2500	RoHS & Green	SN	Level-3-260C-168 HR	-40 to 125	7A6550Q1	<a href="#">Samples</a>

(1) The marketing status values are defined as follows:

**ACTIVE:** Product device recommended for new designs.

**LIFEBUY:** TI has announced that the device will be discontinued, and a lifetime-buy period is in effect.

**NRND:** Not recommended for new designs. Device is in production to support existing customers, but TI does not recommend using this part in a new design.

**PREVIEW:** Device has been announced but is not in production. Samples may or may not be available.

**OBSOLETE:** TI has discontinued the production of the device.

(2) **RoHS:** TI defines "RoHS" to mean semiconductor products that are compliant with the current EU RoHS requirements for all 10 RoHS substances, including the requirement that RoHS substance do not exceed 0.1% by weight in homogeneous materials. Where designed to be soldered at high temperatures, "RoHS" products are suitable for use in specified lead-free processes. TI may reference these types of products as "Pb-Free".

**RoHS Exempt:** TI defines "RoHS Exempt" to mean products that contain lead but are compliant with EU RoHS pursuant to a specific EU RoHS exemption.

**Green:** TI defines "Green" to mean the content of Chlorine (Cl) and Bromine (Br) based flame retardants meet JS709B low halogen requirements of <=1000ppm threshold. Antimony trioxide based flame retardants must also meet the <=1000ppm threshold requirement.

(3) MSL, Peak Temp. - The Moisture Sensitivity Level rating according to the JEDEC industry standard classifications, and peak solder temperature.

(4) There may be additional marking, which relates to the logo, the lot trace code information, or the environmental category on the device.

(5) Multiple Device Markings will be inside parentheses. Only one Device Marking contained in parentheses and separated by a "~" will appear on a device. If a line is indented then it is a continuation of the previous line and the two combined represent the entire Device Marking for that device.

(6) Lead finish/Ball material - Orderable Devices may have multiple material finish options. Finish options are separated by a vertical ruled line. Lead finish/Ball material values may wrap to two lines if the finish value exceeds the maximum column width.

**Important Information and Disclaimer:**The information provided on this page represents TI's knowledge and belief as of the date that it is provided. TI bases its knowledge and belief on information provided by third parties, and makes no representation or warranty as to the accuracy of such information. Efforts are underway to better integrate information from third parties. TI has taken and continues to take reasonable steps to provide representative and accurate information but may not have conducted destructive testing or chemical analysis on incoming materials and chemicals. TI and TI suppliers consider certain information to be proprietary, and thus CAS numbers and other limited information may not be available for release.

In no event shall TI's liability arising out of such information exceed the total purchase price of the TI part(s) at issue in this document sold by TI to Customer on an annual basis.



**TAPE AND REEL INFORMATION**

**QUADRANT ASSIGNMENTS FOR PIN 1 ORIENTATION IN TAPE**

\*All dimensions are nominal

Device	Package Type	Package Drawing	Pins	SPQ	Reel Diameter (mm)	Reel Width W1 (mm)	A0 (mm)	B0 (mm)	K0 (mm)	P1 (mm)	W (mm)	Pin1 Quadrant
TPS7A6533QKVURQ1	TO-252	KVU	3	2500	330.0	16.4	6.9	10.5	2.7	8.0	16.0	Q2
TPS7A6550QKVURQ1	TO-252	KVU	3	2500	330.0	16.4	6.9	10.5	2.7	8.0	16.0	Q2



**TAPE AND REEL BOX DIMENSIONS**

\*All dimensions are nominal

Device	Package Type	Package Drawing	Pins	SPQ	Length (mm)	Width (mm)	Height (mm)
TPS7A6533QKVURQ1	TO-252	KVU	3	2500	340.0	340.0	38.0
TPS7A6550QKVURQ1	TO-252	KVU	3	2500	340.0	340.0	38.0

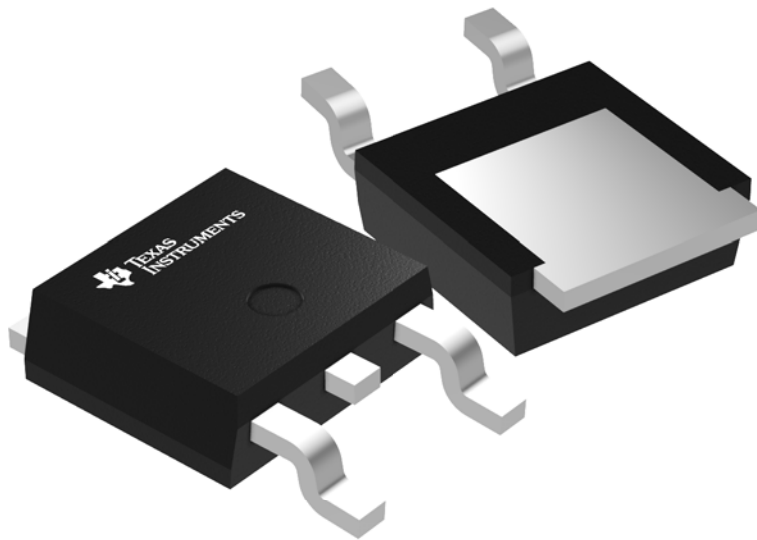

Images above are just a representation of the package family, actual package may vary.  
Refer to the product data sheet for package details.



# PACKAGE OUTLINE

## KVVU0003A

### TO-252 - 2.52 mm max height

TO-252

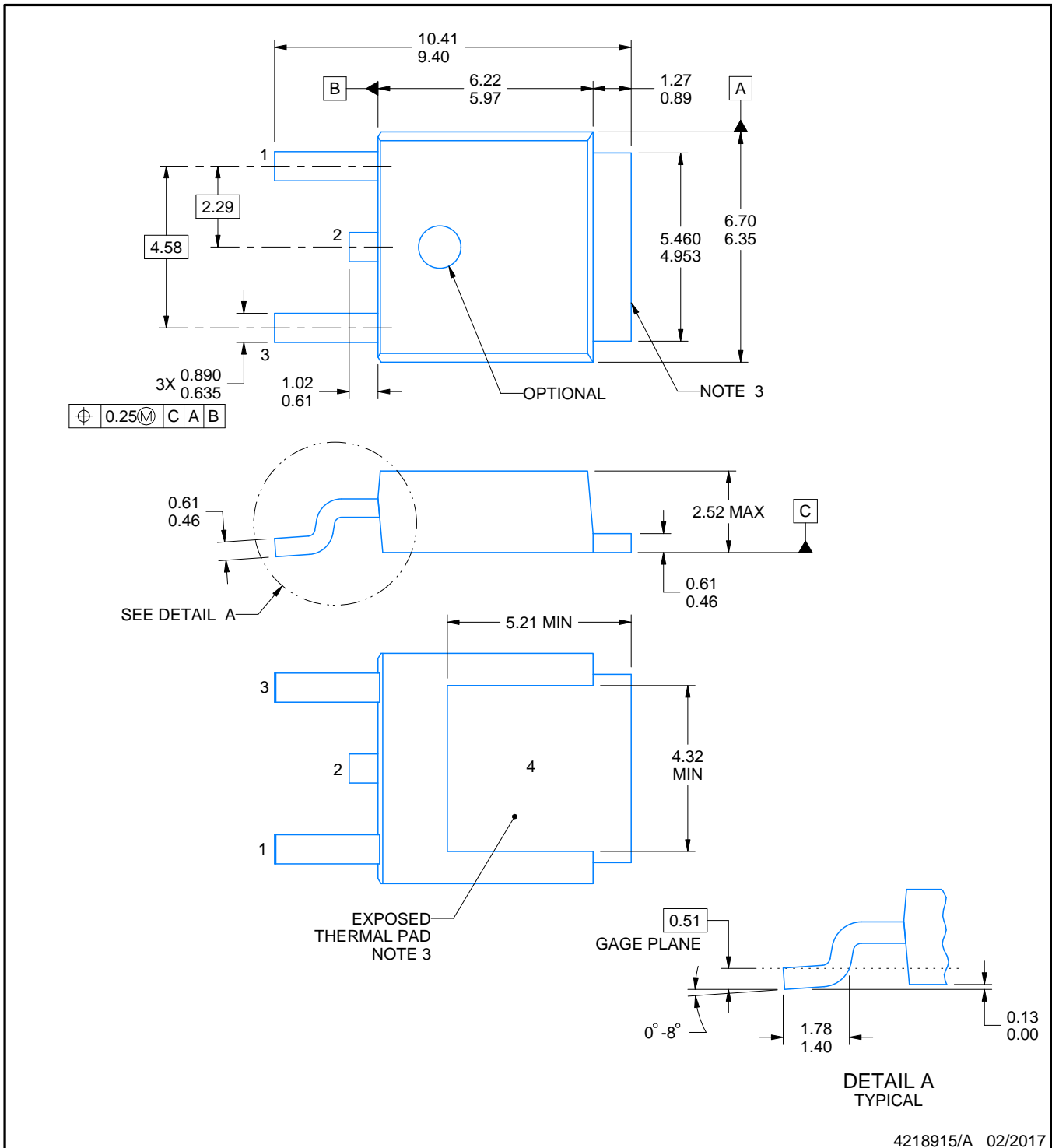

4218915/A 02/2017

#### NOTES:

1. All linear dimensions are in millimeters. Any dimensions in parenthesis are for reference only. Dimensioning and tolerancing per ASME Y14.5M.
2. This drawing is subject to change without notice.
3. Shape may vary per different assembly sites.
4. Reference JEDEC registration TO-252.

# EXAMPLE BOARD LAYOUT

**KVU0003A**

**TO-252 - 2.52 mm max height**

TO-252

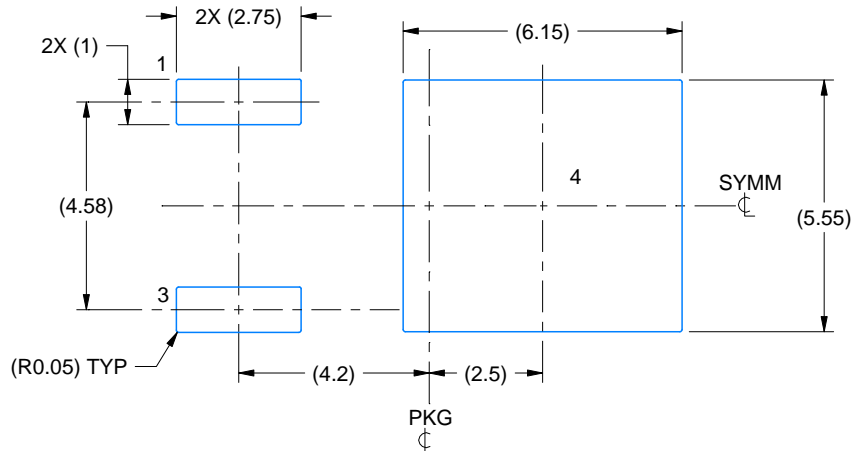

**LAND PATTERN EXAMPLE**  
EXPOSED METAL SHOWN  
SCALE:6X

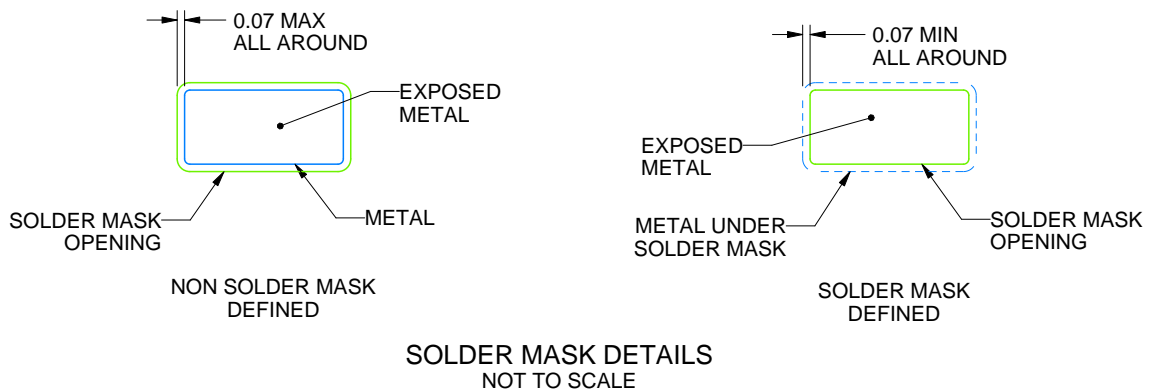

4218915/A 02/2017

NOTES: (continued)

5. This package is designed to be soldered to a thermal pad on the board. For more information, see Texas Instruments literature numbers SLMA002 ([www.ti.com/lit/slm002](http://www.ti.com/lit/slm002)) and SLMA004 ([www.ti.com/lit/slma004](http://www.ti.com/lit/slma004)).
6. Vias are optional depending on application, refer to device data sheet. It is recommended that vias under paste be filled, plugged or tented.

# EXAMPLE STENCIL DESIGN

KVU0003A

TO-252 - 2.52 mm max height

TO-252

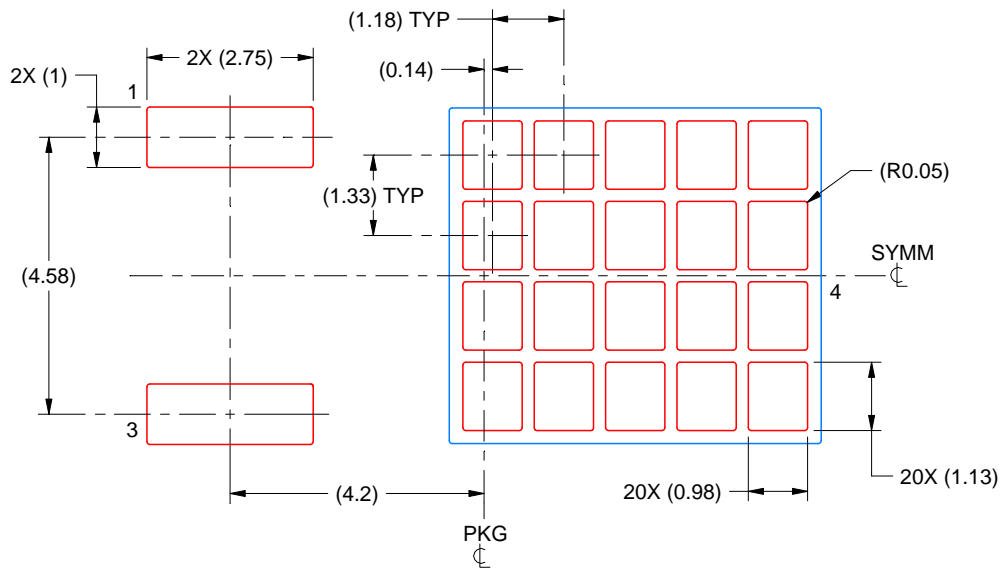

SOLDER PASTE EXAMPLE  
BASED ON 0.125 mm THICK STENCIL

EXPOSED PAD  
65% PRINTED SOLDER COVERAGE BY AREA  
SCALE:8X

4218915/A 02/2017

NOTES: (continued)

7. Laser cutting apertures with trapezoidal walls and rounded corners may offer better paste release. IPC-7525 may have alternate design recommendations.
8. Board assembly site may have different recommendations for stencil design.

## 重要声明和免责声明

TI 均以“原样”提供技术性及其可靠性数据（包括数据表）、设计资源（包括参考设计）、应用或其他设计建议、网络工具、安全信息和其他资源，不保证其中不含任何瑕疵，且不做任何明示或暗示的担保，包括但不限于对适销性、适合某特定用途或不侵犯任何第三方知识产权的暗示担保。

所述资源可供专业开发人员应用TI 产品进行设计使用。您将对以下行为独自承担全部责任：(1) 针对您的应用选择合适的TI 产品；(2) 设计、验证并测试您的应用；(3) 确保您的应用满足相应标准以及任何其他安全、安保或其他要求。所述资源如有变更，恕不另行通知。TI 对您使用所述资源的授权仅限于开发资源所涉及TI 产品的相关应用。除此之外不得复制或展示所述资源，也不提供其它TI 或任何第三方的知识产权授权许可。如因使用所述资源而产生任何索赔、赔偿、成本、损失及债务等，TI 对此概不负责，并且您须赔偿由此对TI 及其代表造成的损害。

TI 所提供产品均受TI 的销售条款 (<http://www.ti.com.cn/zh-cn/legal/termsofsale.html>) 以及ti.com.cn上或随附TI产品提供的其他可适用条款的约束。TI提供所述资源并不扩展或以其他方式更改TI 针对TI 产品所发布的可适用的担保范围或担保免责声明。

邮寄地址：上海市浦东新区世纪大道 1568 号中建大厦 32 楼，邮政编码：200122

Copyright © 2020 德州仪器半导体技术（上海）有限公司